

## TERMINALS OF ECM

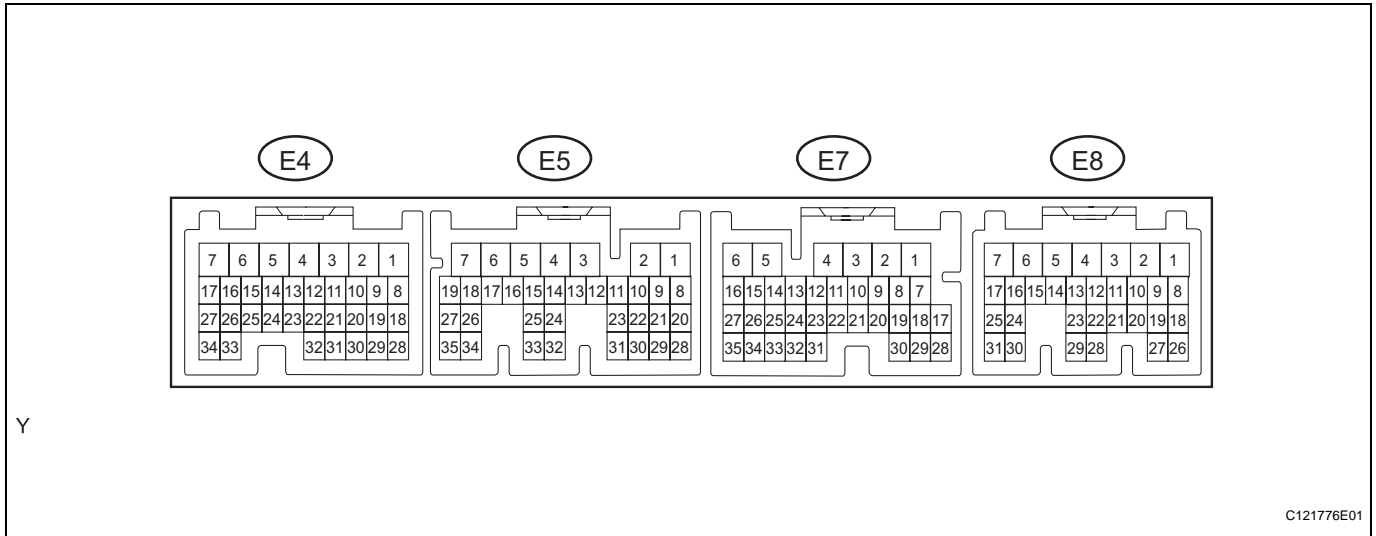

**HINT:**

The standard normal voltage between each pair of ECM terminals is shown in the table below. The appropriate conditions for checking each pair of terminals are also indicated. The result of checks should be compared with the standard normal voltage for that pair of terminals, displayed in the STD Voltage column. The illustration above can be used as a reference to identify the ECM terminal locations.

Symbols (Terminals No.)	Wiring Colors	Terminal Descriptions	Conditions	STD Voltages
BATT (E8-3) - E1 (E4-3)	L - BR	Battery (for measuring battery voltage and for ECM memory)	Always	9 to 14 V
+BM (E8-7) - E1 (E4-3)	LG - BR	Power source of throttle motor	Always	9 to 14 V
IGSW (E8-9) - E1 (E4-3)	O - BR	Ignition switch	Ignition switch ON	9 to 14 V
+B (E8-1) - E1 (E4-3)	B - BR	Power source of ECM	Ignition switch ON	9 to 14 V
MREL (E8-8) - E1 (E4-3)	G-W - BR	EFI relay	Ignition switch ON	9 to 14 V
VC (E4-18) - E2 (E4-28)	L - BR	Power source of sensor (specific voltage)	Ignition switch ON	4.5 to 5.0 V
VTA1 (E4-20) - E2 (E4-28)	G-B - BR	Throttle position sensor (for engine control)	Ignition switch ON, Accelerator pedal fully released	0.5 to 1.1 V
VTA1 (E4-20) - E2 (E4-28)	G-B - BR	Throttle position sensor (for engine control)	Ignition switch ON, Accelerator pedal fully depressed	3.3 to 4.9 V
VTA2 (E4-19) - E2 (E4-28)	G-W - BR	Throttle position sensor (for sensor malfunction detection)	Ignition switch ON, Accelerator pedal fully released	2.1 to 3.1 V
VTA2 (E4-19) - E2 (E4-28)	G-W - BR	Throttle position sensor (for sensor malfunction detection)	Ignition switch ON, Accelerator pedal fully depressed	4.5 to 5.0 V
VPA (E8-18) - EPA (E8-20)	R-Y - LG-B	Accelerator pedal position sensor (for engine control)	Ignition switch ON, Accelerator pedal fully released	0.5 to 1.1 V
VPA (E8-18) - EPA (E8-20)	R-Y - LG-B	Accelerator pedal position sensor (for engine control)	Ignition switch ON, Accelerator pedal fully depressed	2.6 to 4.5 V
VPA2 (E8-19) - EPA2 (E8-21)	GR-B - R-B	Accelerator pedal position sensor (for sensor malfunction detection)	Ignition switch ON, Accelerator pedal fully released	1.2 to 2.0 V
VPA2 (E8-19) - EPA2 (E8-21)	GR-B - R-B	Accelerator pedal position sensor (for sensor malfunction detection)	Ignition switch ON, Accelerator pedal fully depressed	3.4 to 5.0 V
VCPA (E8-26) - EPA (E8-20)	R - LG-B	Power source of accelerator pedal position sensor (for VPA)	Ignition switch ON	4.5 to 5.0 V
VCP2 (E8-27) - EPA2 (E8-21)	L-W - R-B	Power source of accelerator pedal position sensor (for VPA2)	Ignition switch ON	4.5 to 5.0 V

Symbols (Terminals No.)	Wiring Colors	Terminal Descriptions	Conditions	STD Voltages
VG (E5-28) - E2G (E5-30)	R-Y - R-W	Mass air flow meter	Idling, Shift position P or N, A/C switch OFF	0.5 to 3.0 V
THA (E5-29) - E2 (E4-28)	R-L - BR	Intake air temperature sensor	Idling, Intake air temperature 20°C (68°F)	0.5 to 3.4 V
THW (E4-32) - E2 (E4-28)	Y-B - BR	Engine coolant temperature sensor	Idling, Engine coolant temperature 80°C (176°F)	0.2 to 1.0 V
#10 (E5-6) - E01 (E4-7) #20 (E5-5) - E01 (E4-7) #30 (E5-2) - E01 (E4-7) #40 (E5-1) - E01 (E4-7)	R-L - W-B B - W-B R - W-B G - W-B	Injector	Ignition switch ON	9 to 14 V
#10 (E5-6) - E01 (E4-7) #20 (E5-5) - E01 (E4-7) #30 (E5-2) - E01 (E4-7) #40 (E5-1) - E01 (E4-7)	R-L - W-B B - W-B R - W-B G - W-B	Injector	Idling	Pulse generation (see waveform 1)
IGT1 (E4-17) - E1 (E4-3) IGT2 (E4-16) - E1 (E4-3) IGT3 (E4-15) - E1 (E4-3) IGT4 (E4-14) - E1 (E4-3)	P - BR P-L - BR LG - BR LG-B - BR	Ignition coil with igniter (ignition signal)	Idling	Pulse generation (see waveform 2)
IGF1 (E4-23) - E1 (E4-3)	W-R - BR	Ignition coil with igniter (ignition confirmation signal)	Ignition switch ON	4.5 to 5.0 V
IGF1 (E4-23) - E1 (E4-3)	W-R - BR	Ignition coil with igniter (ignition confirmation signal)	Idling	Pulse generation (see waveform 2)
G2 (E4-26) - NE- (E4-34)	L - G	Camshaft position sensor	Idling	Pulse generation (see waveform 3)
NE+ (E4-27) - NE- (E4-34)	R - G	Crankshaft position sensor	Idling	Pulse generation (see waveform 3)
FC (E8-25) - E1 (E4-3)	L-B - BR	Fuel pump control	Ignition switch ON	9 to 14 V
FC (E8-25) - E1 (E4-3)	L-B - BR	Fuel pump control	Idling	Below 1.5 V
M+ (E4-5) - ME01 (E5-3)	P - W-B	Throttle actuator	Idling with warm engine	Pulse generation (see waveform 4)
M- (E4-4) - ME01 (E5-3)	L - W-B	Throttle actuator	Idling with warm engine	Pulse generation (see waveform 5)
A1A+ (E4-21) - E1 (E4-3)	P - BR	A/F sensor	Always (Ignition switch ON)	3.3 V <sup>*1</sup>
A1A- (E4-31) - E1 (E4-3)	L - BR	A/F sensor	Always (Ignition switch ON)	3.0 V <sup>*1</sup>
OX1B (E4-25) - E2 (E4-28)	W - BR	Heated oxygen sensor	Engine speed maintained 2,500 rpm for 2 minutes after warming up sensor	Pulse generation (see waveform 6)
HA1A (E4-1) - E04 (E5-7)	R - W-B	A/F sensor heater	Idling	Below 3.0 V
HA1A (E4-1) - E04 (E5-7)	R - W-B	A/F sensor heater	Ignition switch ON	9 to 14 V
HT1B (E4-2) - E03 (E5-4)	G - W-B	Heated oxygen sensor heater	Idling	Below 3.0 V
HT1B (E4-2) - E03 (E5-4)	G - W-B	Heated oxygen sensor heater	Ignition switch ON	9 to 14 V
KNK1 (E4-29) - EKNK (E4-30)	B - W	Knock sensor	Maintain engine speed 4,000 rpm after warming up engine	Pulse generation (see waveform 7)
OC1+ (E4-13) - OC1- (E4-12)	L-W - W	Camshaft timing oil control valve (OCV)	Idling	Pulse generation (see waveform 8)
PRG (E5-23) - E01 (E4-7)	Y - W-B	Purge VSV	Ignition switch ON	9 to 14 V
PRG (E5-23) - E01 (E4-7)	Y - W-B	Purge VSV	Idling	Pulse generation (see waveform 9)
VPMP (E8-5) - E1 (E4-3)	V-W - BR	Vent valve (built into canister pump module)	Ignition switch ON	9 to 14 V

Symbols (Terminals No.)	Wiring Colors	Terminal Descriptions	Conditions	STD Voltages
MPMP (E8-6) - E1 (E4-3)	G - BR	Leak detection pump (built into canister pump module)	• Leak detection pump OFF	0 to 3 V
MPMP (E8-6) - E1 (E4-3)	G - BR	Leak detection pump (built into canister pump module)	• Leak detection pump ON	9 to 14 V
PPMP (E8-31) - E2 (E4-28)	GR - BR	Canister pressure sensor (built into canister pump module)	Ignition switch ON	3 to 3.6 V
STA (E8-12) - E1 (E4-3)	B-Y - BR	Starter signal	Shift position N, Ignition switch START	5.5 V or more
STP (E7-4) - E1 (E4-3)	L - BR	Stop light switch	Brake pedal depressed	7.5 to 14 V
STP (E7-4) - E1 (E4-3)	L - BR	Stop light switch	Brake pedal released	Below 1.5 V
ST1- (E8-16) - E1 (E4-3)	V-W - BR	Stop light switch	Ignition switch ON, Brake pedal depressed	Below 1.5 V
ST1- (E8-16) - E1 (E4-3)	V-W - BR	Stop light switch	Ignition switch ON, Brake pedal released	7.5 to 14 V
W (E7-30) - E01 (E4-7)	BR - W-B	MIL	Idling	9 to 14 V
W (E7-30) - E01 (E4-7)	BR - W-B	MIL	Ignition switch ON	Below 3.5 V
ELS (E8-15) - E1 (E4-3)	G - BR	Electric load	Tail light switch ON	7.5 to 14 V
ELS (E8-15) - E1 (E4-3)	G - BR	Electric load	Tail light switch OFF	0 to 1.5 V
ELS2 (E7-20) - E1 (E4-3)	B-W - BR	Electric load	Vehicle stationary, Voltage inverter outputs more than 100 W	9 to 14 V
ELS2 (E7-20) - E1 (E4-3)	B-W - BR	Electric load	Vehicle stationary, Voltage inverter outputs 100 W or less	0 to 1.5 V
TACH (E7-1) - E1 (E4-3)	B-W - BR	Engine speed	Idling	Pulse generation (see waveform 10)
SPD (E7-8) - E1 (E4-3)	V-W - BR	Speed signal from combination meter	Driving at 12 mph (20 km/h)	Pulse generation (see waveform 11)
TC (E7-17) - E1 (E4-3)	P-B - BR	Terminal TC of DLC 3	Ignition switch ON	9 to 14 V
PSW (E5-32) - E1 (E4-3)	G-W - BR	Power steering oil pressure switch	While turning steering wheel	Below 1.5 V
F/PS (E7-32) - E1 (E4-3)	R - BR	Airbag sensor assembly	Idling with warm engine	Pulse generation (see waveform 12)
NSW (E8-30) - E1 (E4-3)	V - BR	Park/Neutral switch signal	IG switch ON and shift lever P or N position	Below 1 V
NSW (E8-30) - E1 (E4-3)	V - BR	Park/Neutral switch signal	IG switch ON and shift lever except P and N	9 to 14 V
*2 CANH (E7-33) - E1 (E4-3)	B - BR	Communication signal with other components	Ignition switch ON	Pulse generation (see waveform 13)
*2 CANL (E7-34) - E1 (E4-3)	W - BR	Communication signal with other components	Ignition switch ON	Pulse generation (see waveform 14)
AIRV (E4-24) - E1 (E4-3)	R-W - BR	Air switching valve for secondary air injection system	Idling	9 to 14 V
AIRP (E4-11) - E1 (E4-3)	Y-R - BR	Air pump control	Idling	9 to 14 V
AIDI (E5-20) - E1 (E4-3)	G-R - BR	Diagnostic information signal for air injection system	Air injection system operates	Pulse generation (see waveform 15)
AIP (E5-22) - E2 (E4-28)	GR - BR	Secondary air injection system pressure signal	Ignition switch ON	4.5 to 5.0 V

\*1: The ECM terminal voltage is constant regardless of the output voltage from the sensor.

\*2: Only for the vehicle equipped with VSC (see page CA-22).

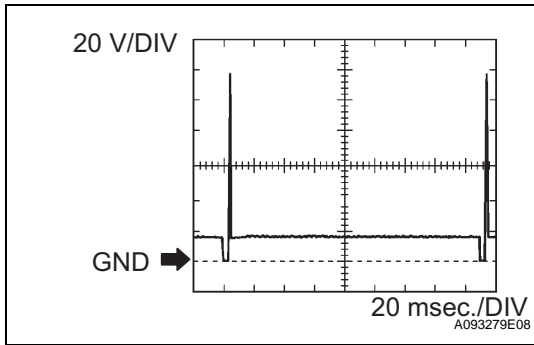

**1. WAVEFORM 1**  
Fuel injector

ECM Terminal Names	Between #10 (to 40) and E01
Tester Ranges	20 V/DIV, 20 msec./DIV
Conditions	Idling

**HINT:**  
The wavelength becomes shorter as the engine rpm increases.

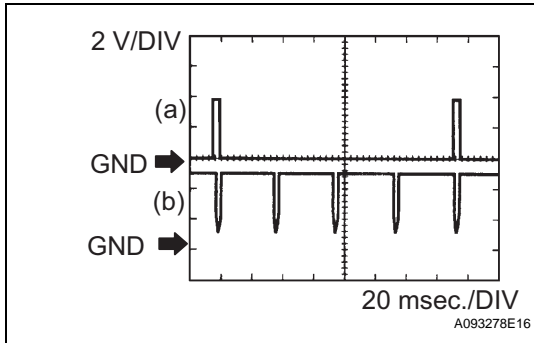

**2. WAVEFORM 2**  
(a) Igniter IGT signal (from ECM to igniter)  
(b) Igniter IGF signal (from igniter to ECM)

ECM Terminal Names	(a) Between IGT (1 to 4) and E1 (b) Between IGF1 and E1
Tester Ranges	2 V/DIV, 20 msec./DIV
Conditions	Idling

**HINT:**  
The wavelength becomes shorter as the engine rpm increases.

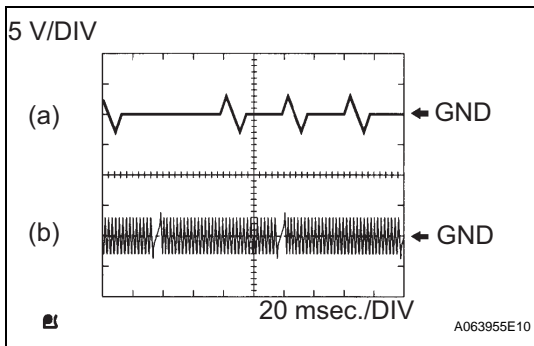

**3. WAVEFORM 3**  
(a) Camshaft position sensor  
(b) Crankshaft position sensor

ECM Terminal Names	(a) Between G2+ and NE- (b) Between NE+ and NE-
Tester Ranges	5 V/DIV, 20 msec./DIV
Conditions	Idling

**HINT:**  
The wavelength becomes shorter as the engine rpm increases.

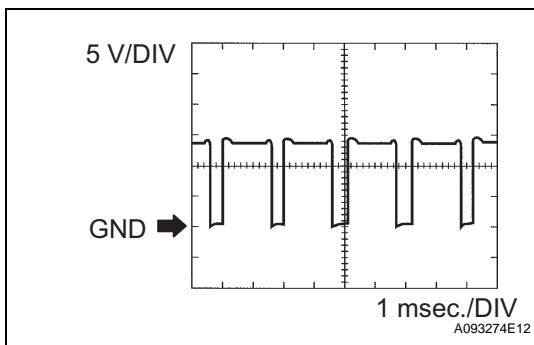

**4. WAVEFORM 4**  
Throttle actuator positive terminal

ECM Terminal Names	Between M+ and ME01
Tester Ranges	5 V/DIV, 1 msec./DIV
Conditions	Idling with warm engine

**HINT:**  
The duty ratio varies depending on the throttle actuator operation.

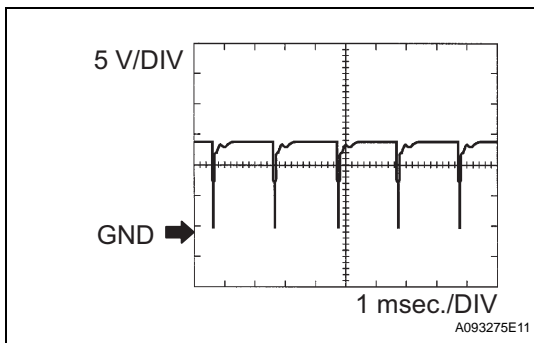

**5. WAVEFORM 5**  
Throttle actuator negative terminal

ECM Terminal Names	Between M- and ME01
Tester Ranges	5 V/DIV, 1 msec./DIV
Conditions	Idling with warm engine

**HINT:**  
The duty ratio varies depending on the throttle actuator operation.

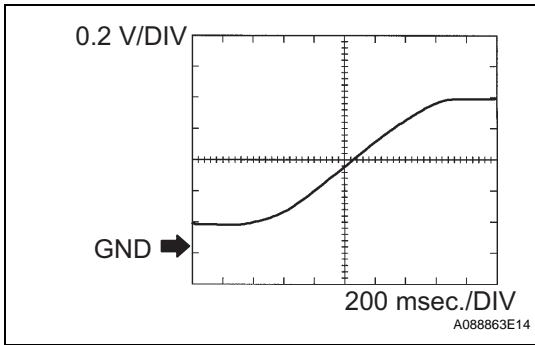

**6. WAVEFORM 6**  
Heated oxygen sensor

ECM Terminal Names	Between OX1B and E2
Tester Ranges	0.2 V/DIV, 200 msec./DIV
Conditions	Engine speed maintained 2,500 rpm for 2 minutes after warming up engine

**HINT:**  
In the DATA LIST, item O2S B1S2 shows the ECM input values from the heated oxygen sensor.

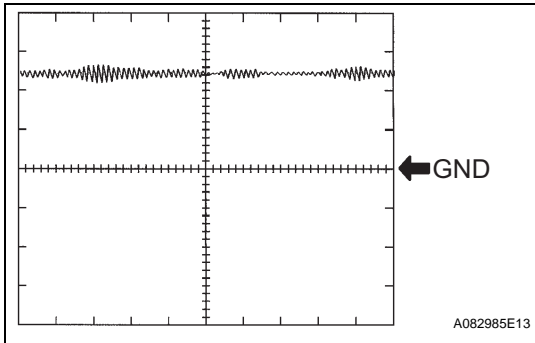

**7. WAVEFORM 7**  
Knock sensor

ECM Terminal Names	Between KNK1 and EKNK
Tester Ranges	0.01 to 10 V/DIV, 0.01 to 10 msec./DIV
Conditions	Engine speed maintained 4,000 rpm after warming up engine

**HINT:**

- The wavelength becomes shorter as the engine rpm increases.
- The waveforms and amplitudes displayed differ slightly depending on the vehicle.

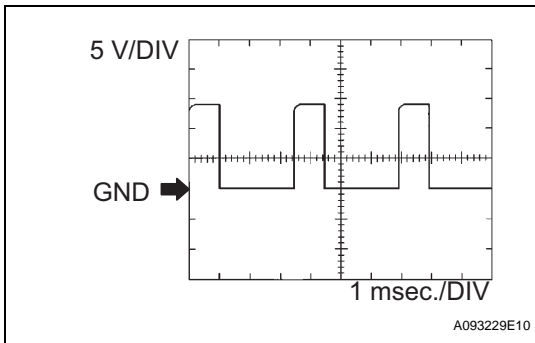

**8. WAVEFORM 8**  
Camshaft timing oil control valve (OCV)

ECM Terminal Names	Between OC1+ and OC1-
Tester Ranges	5 V/DIV, 1 msec./DIV
Conditions	Idling

**HINT:**  
The wavelength becomes shorter as the engine rpm increases.

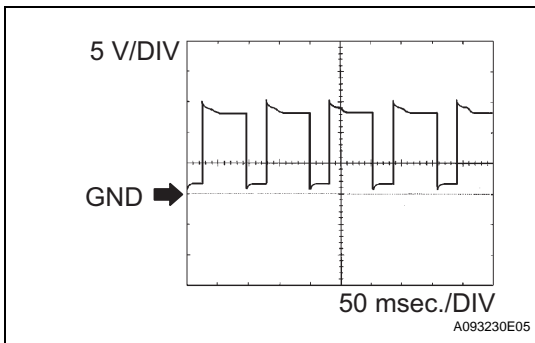

**9. WAVEFORM 9**  
EVAP VSV

ECM Terminal Names	Between PRG and E01
Tester Ranges	5 V/DIV, 50 msec./DIV
Conditions	Idling

**HINT:**  
If the waveform is not similar to the illustration, check the waveform again after idling for 10 minutes or more.

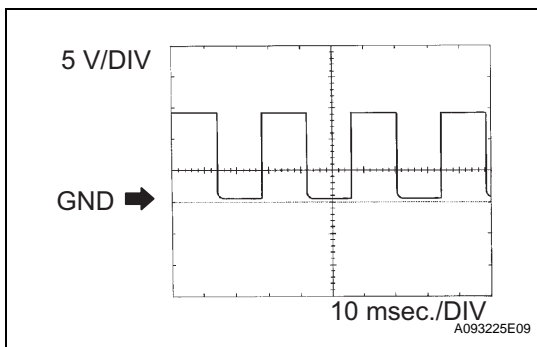

**10. WAVEFORM 10**  
Engine speed signal

ECM Terminal Names	Between TACH and E1
Tester Ranges	5 V/DIV, 10 msec./DIV
Conditions	Idling

**HINT:**  
The wavelength becomes shorter as the engine rpm increases.

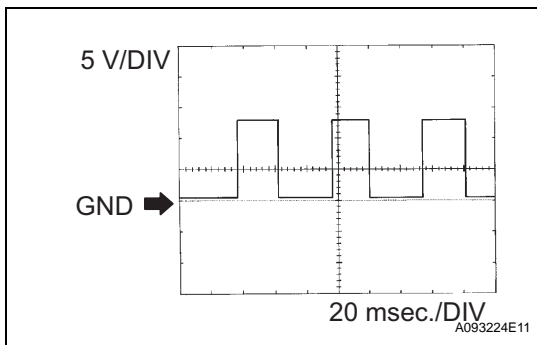

**11. WAVEFORM 11**  
Vehicle speed signal

ECM Terminal Names	Between SPD and E1
Tester Ranges	5 V/DIV, 20 msec./DIV
Conditions	Driving at 12 mph (20 km/h)

**HINT:**  
The wavelength becomes shorter as the vehicle speed increases.

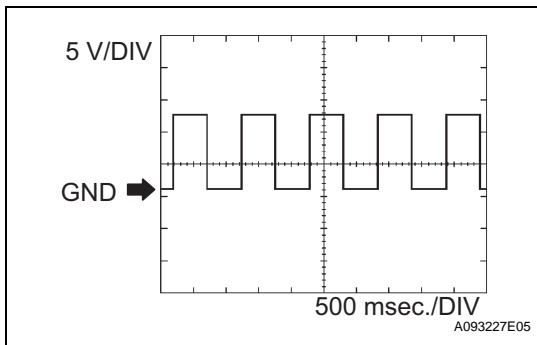

**12. WAVEFORM 12**  
Airbag sensor assembly

ECM Terminal Names	Between F/PS and E1
Tester Ranges	5 V/DIV, 500 msec./DIV
Conditions	Idling with warm engine

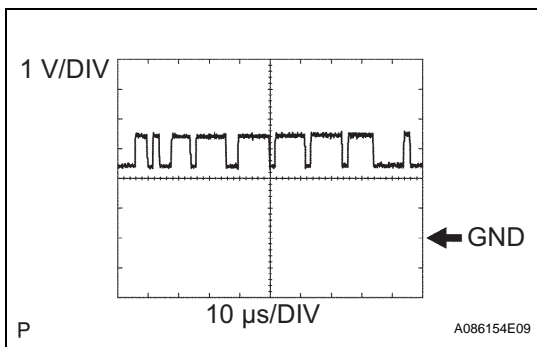

**13. WAVEFORM 13**  
CAN communication signal (reference)

ECM Terminal Names	Between CANH and E1
Tester Ranges	1 V/DIV, 10 µs/DIV
Conditions	Ignition switch ON

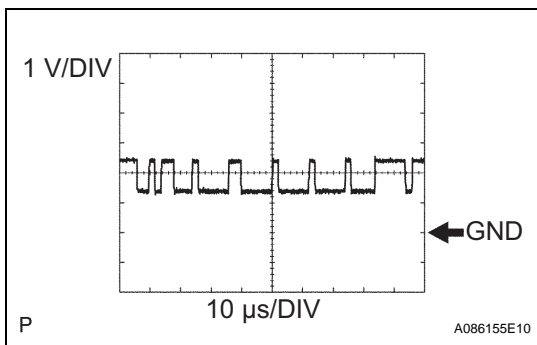

**14. WAVEFORM 14**  
CAN communication signal (reference)

ECM Terminal Names	Between CANL and E1
Tester Ranges	1 V/DIV, 10 µs/DIV
Conditions	Ignition switch ON

ES

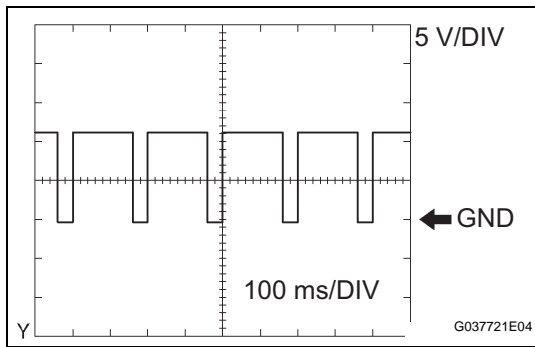
**15. WAVEFORM 15**

Terminal DI of air injection control driver

ECM Terminal Names	Between AIDI and E1
Tester Ranges	5 V/DIV, 100 ms/DIV
Conditions	Performing ACTIVE TEST using intelligent tester (air injection system)

**HINT:**

The wavelength changes when the air injection control driver detects malfunctions in the air injection system (see page [ES-193](#)).